

Diritti riservati All rights reserved

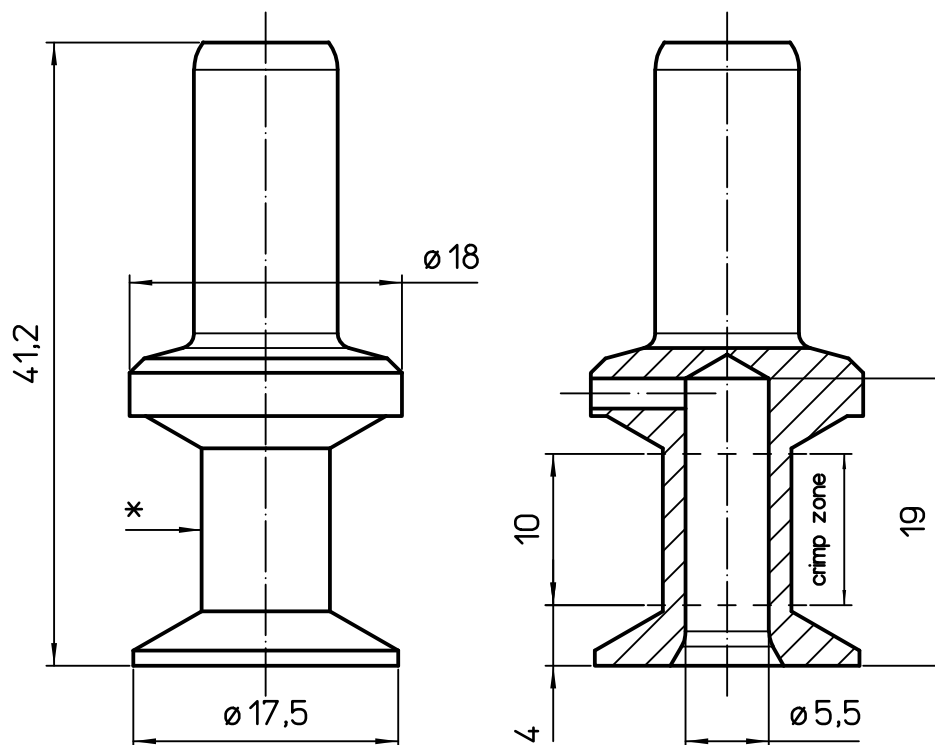

- * number of crimps: 1
- assembly instructions see catalogue
- crimp zone according to DIN 46235; indicator MK 8
- for stranded wire according to IEC 60228 class 5
- stripping length: 19 mm

REV.	DATE	SIGNATURE



Dimensions
in mm

Simplified representation with dimensions without tolerance

Original Size A4

Date 21/02/23

Sign. S.Diasparra

C30MA 16

Turned silver plated male crimp contact, 300 A, wire cross-section 16 mm² / AWG 6

Scale

2:1

